

ENG-Installation manual
RU-Инструкция по установке
ESP-Manual de instalación



Installation Notice:

- a. Read this installation manual carefully before installation. Check all fittings according to the fitting list. Prepare all parts and tools needed and install the product following the installation procedures.
- b. Handle the glass gently. Ask somebody for help if needed. Use rubber hammer to knock if necessary while installing. To protect the glass from being destroyed, do not use something hard to knock the glass, especially knock the corner of the glass.

Usage Notice:

- a. Children use it with adult's care.
- b. Please clean the shower room with soft cloth and mild-detergents
- c. Avoid things flowing into drainage which may cause obstructed.

Instrucciones:

- a. Lea cuidadosamente este manual antes de instalar. Revise todos los accesorios de acuerdo al listado. Prepare todas las piezas y herramientas necesarias e instale el producto siguiendo las instrucciones.
- b. Manejar el vaso suavemente. Pregunte a alguien en busca de ayuda si es necesario. Utilice un martillo de goma para golpear si es necesario durante la instalación. Para proteger el vidrio de ser destruido, no use algo difícil de golpear el cristal, sobre todo golpear la esquina del cristal.

Importante:

- a. Los niños deben usar este producto bajo la supervisión de un adulto.
- b. Limpie con un paño húmedo y un detergente neutro.
- c. Evite obstruir el drenaje.

Информация перед установкой

- а. Прочитайте внимательно инструкцию перед началом сбора. Проверьте наличие всех деталей в соответствии со списком. Подготовьте все детали и инструменты, необходимые для установки и начинайте сбор в соответствии с указанными инструкциями.
- б. Транспортируйте стекло осторожно. Попросите кого-то о помощи, если это необходимо. Используйте резиновый молоток при установлении стекла. С целью предотвращения повреждения стекла не наносите по нему удары тяжелыми предметами, берегите уголки стекла от повреждений.







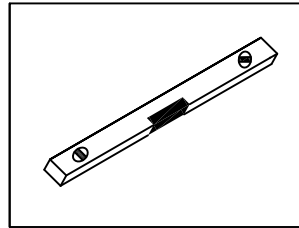
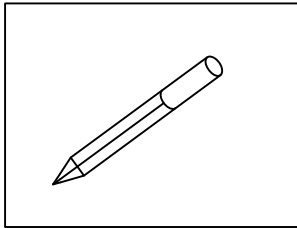
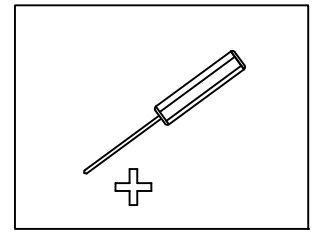
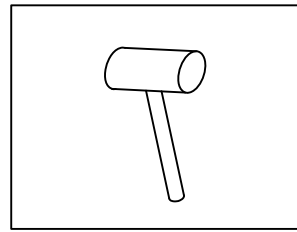
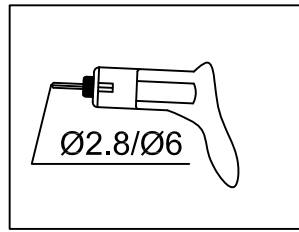
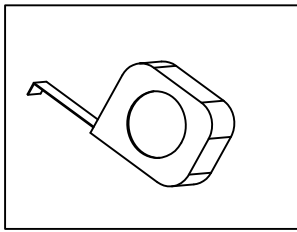







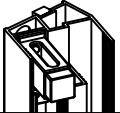
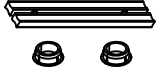

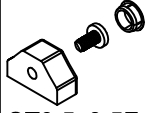





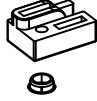
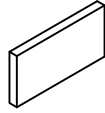

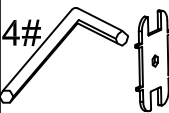
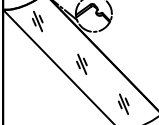

Информация для пользователя:

- а. Дети могут пользоваться кабиной лишь под надзором взрослых.
- б. Для мойки кабины используйте мягкую ткань и не агрессивные моющие средства.

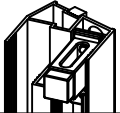
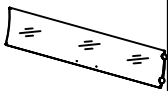
Tools/Инструменты /Instrumentos:

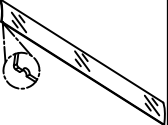

Spare parts list/Комплектация/ Lista de piezas de repuesto:

①		x8	⑩		x1	⑲		x1	⑳		x1
②		x1	⑪		x1	⑳		x1	㉑		x1
③	 L=1857	x2	⑫	 L=550	x3	㉑		x1	⑳		x1
④	 ST4.2x32	x8	⑬	 L=638	x2	㉒		x1	㉑		x1
⑤	 L=1872	x2	⑭		x1	㉓	 ST3.5x9.5	x2	㉒		x1
⑥		x1	⑮	 ST3.5x16	x1	㉔		x2			
⑦	 L=1801	x1	⑯		x1	㉕		x1			
⑧	 L=1852	x1	⑰	 M4x12	x2	㉖	 L=265	x3			
⑨		x1	⑱		x1	㉗		x1			

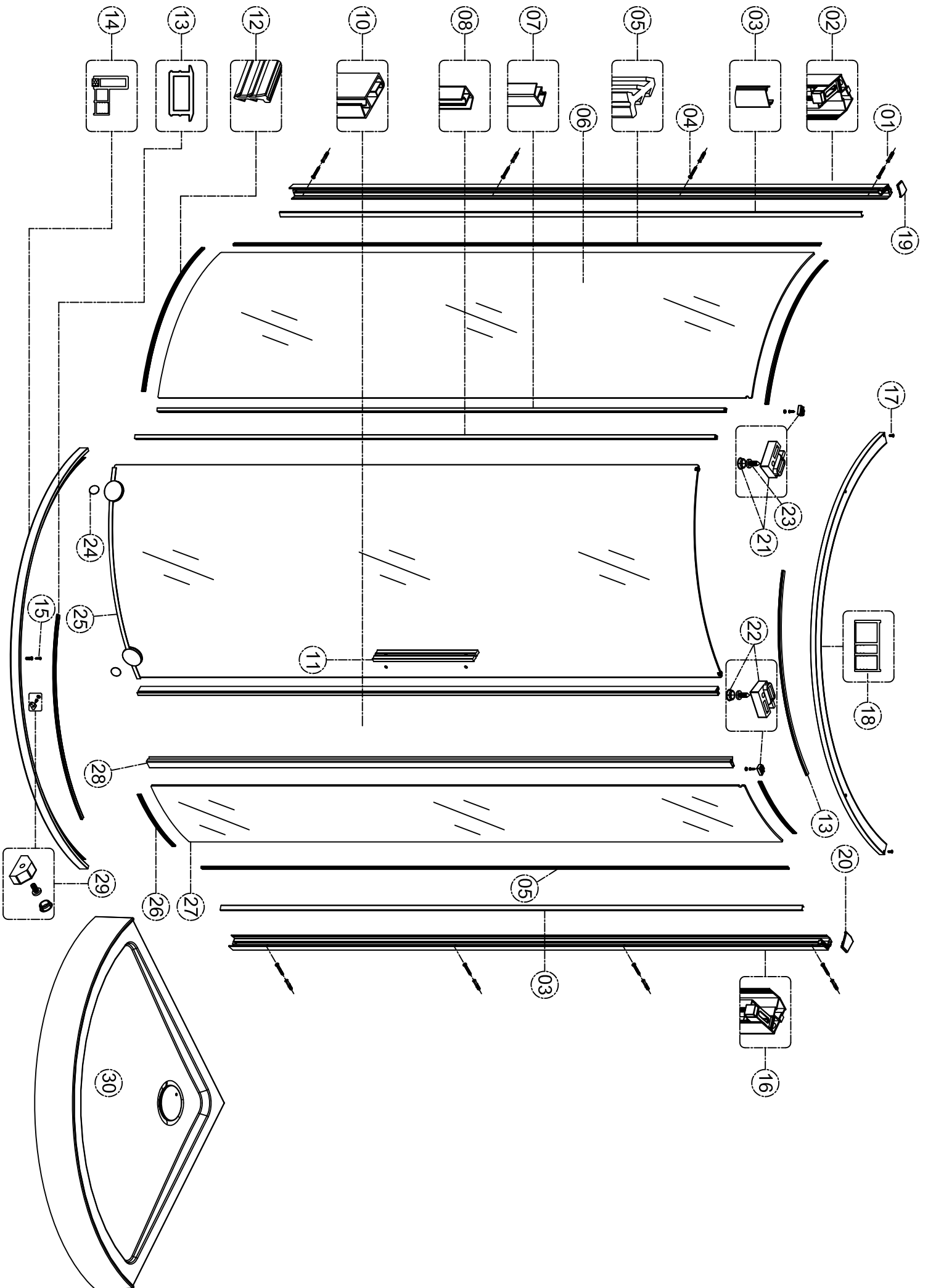

1.)

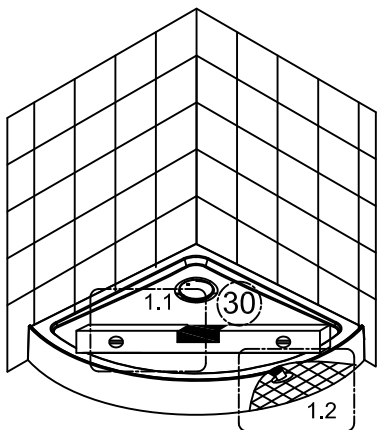
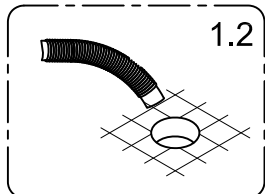
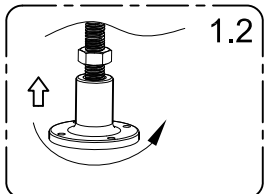
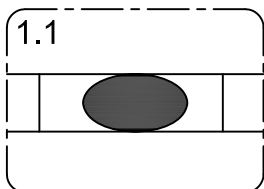

2.)

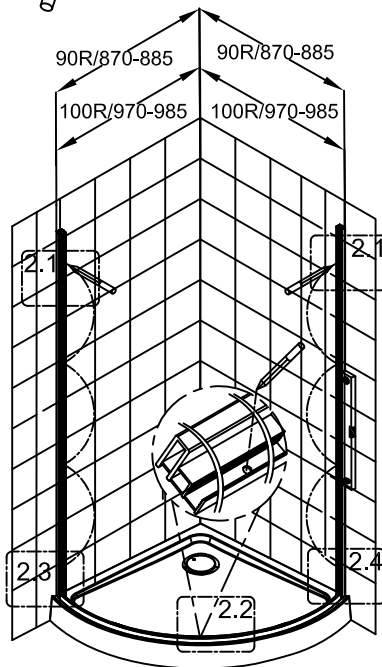
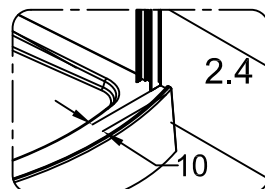
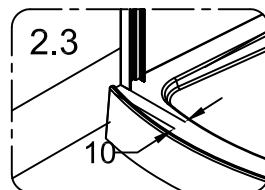
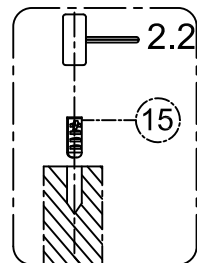
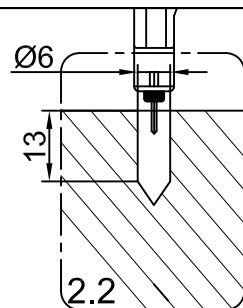
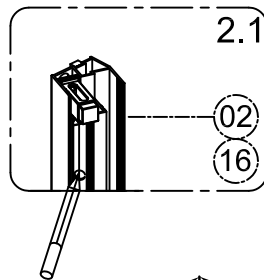

3.)

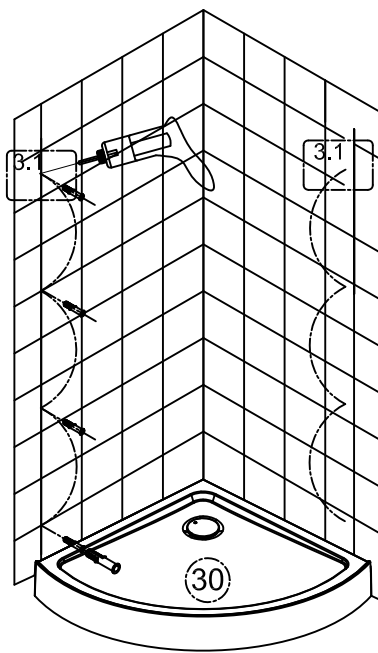
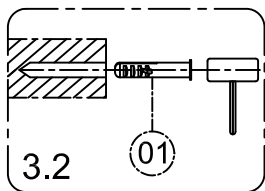
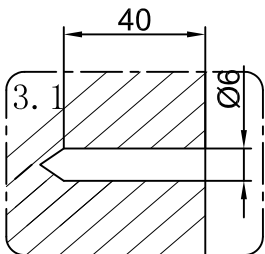

4.)

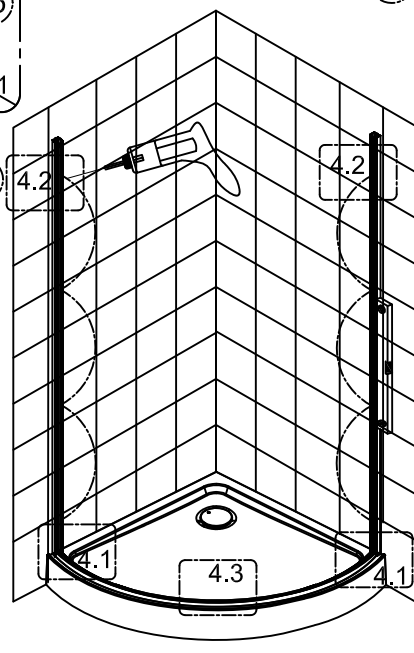
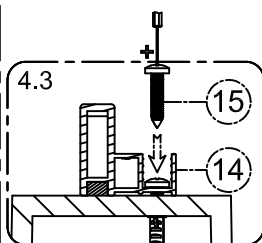
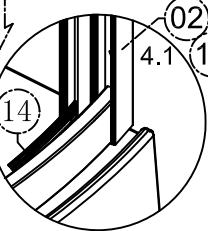
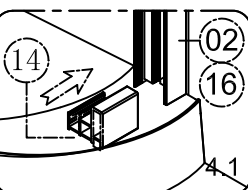
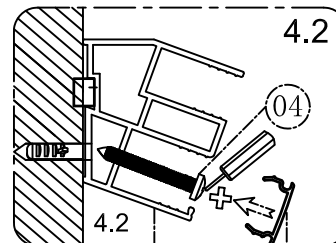
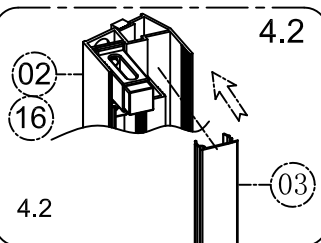

5.)

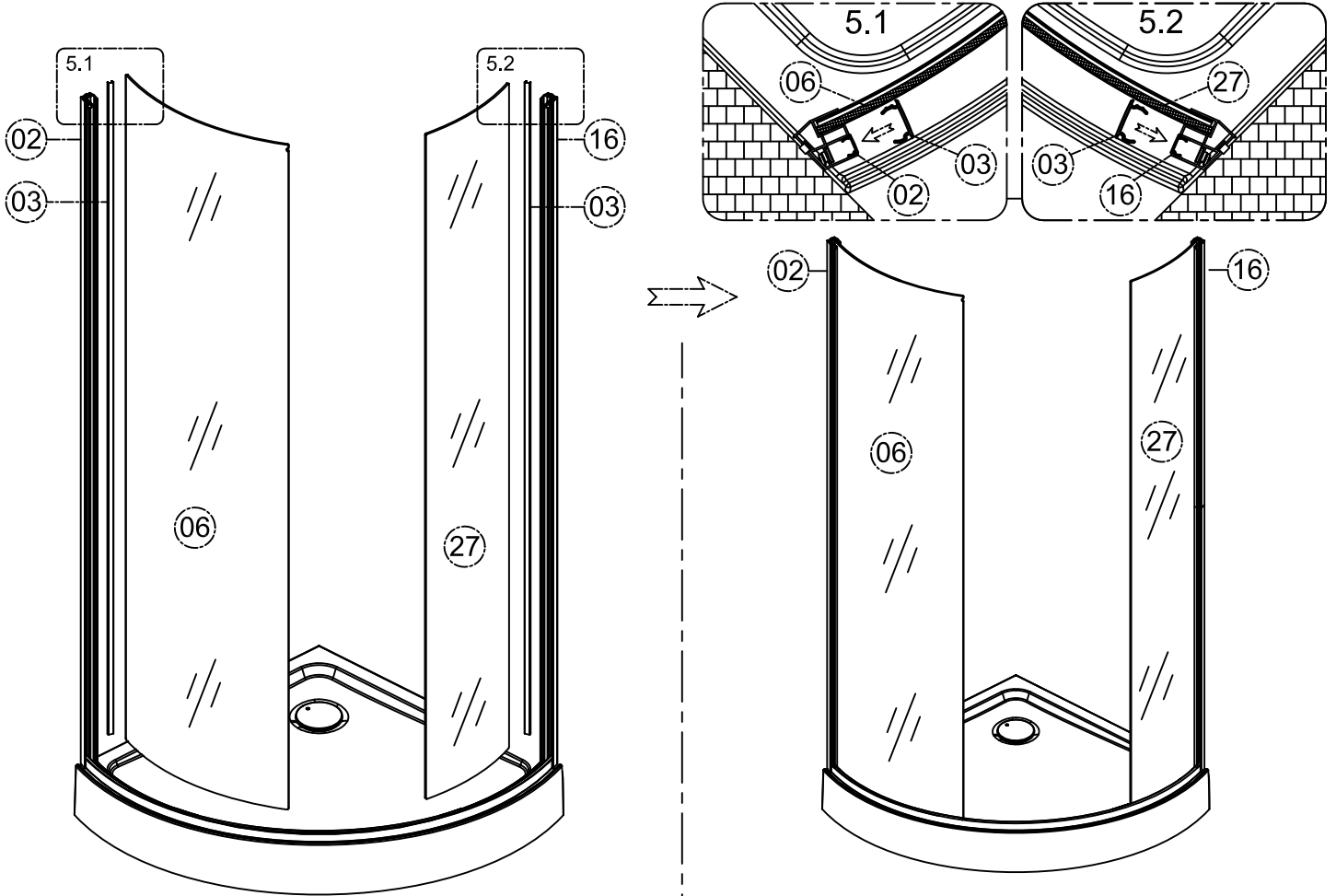

6.)

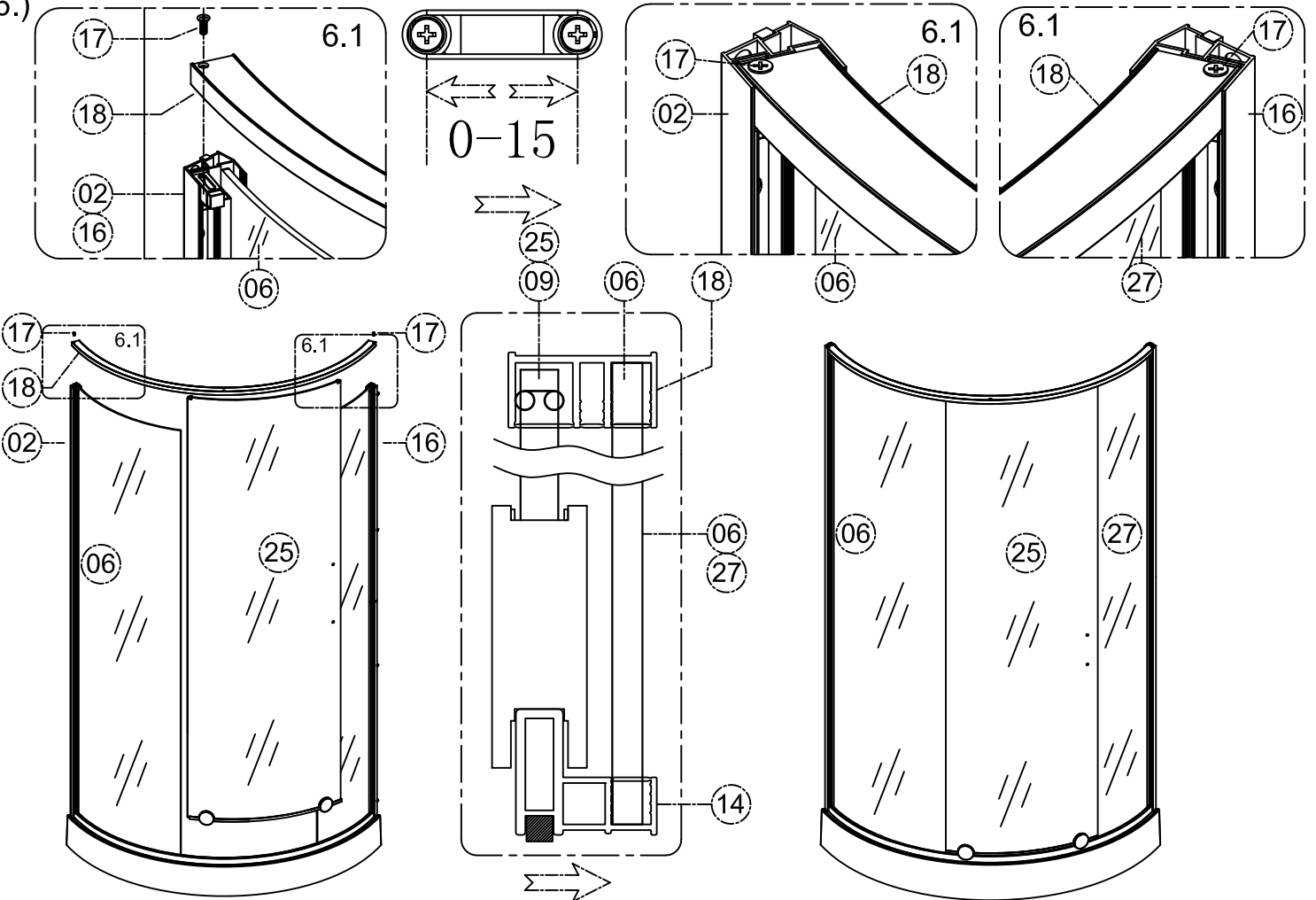

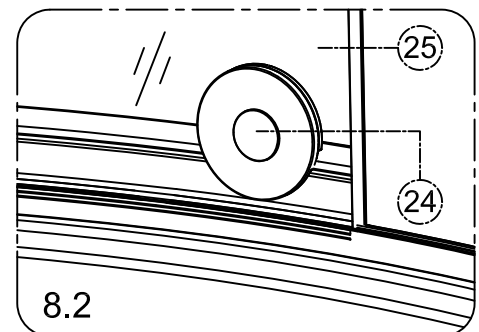
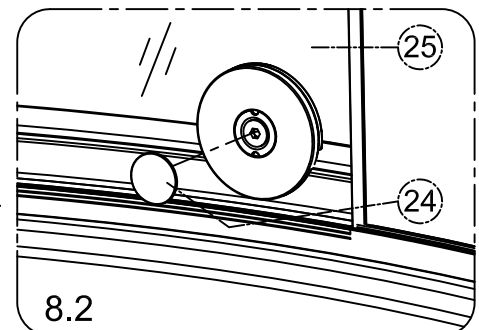
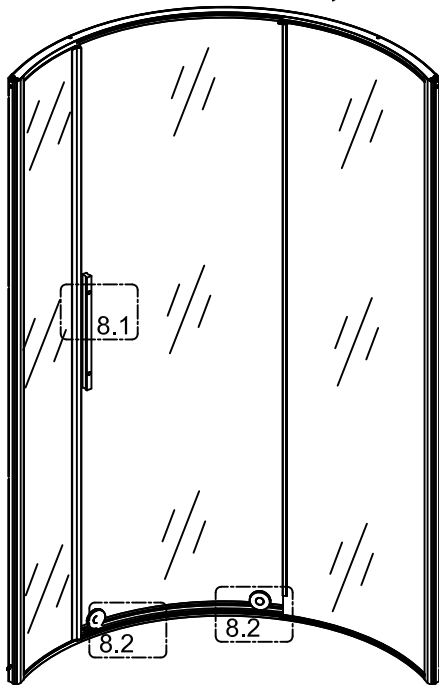
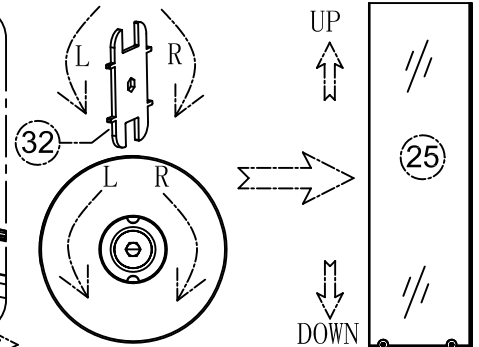
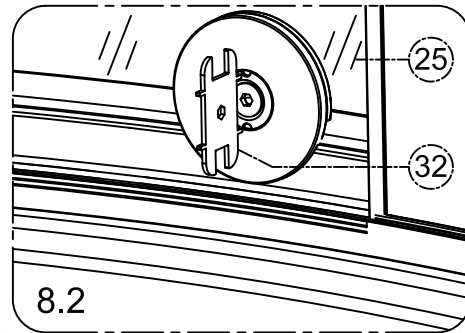
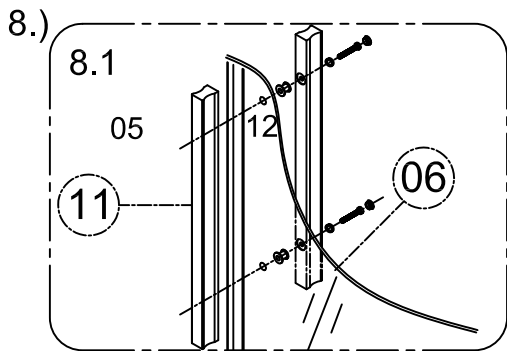
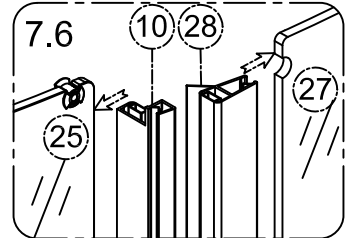
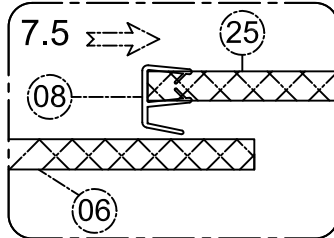
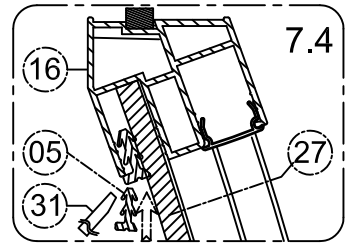
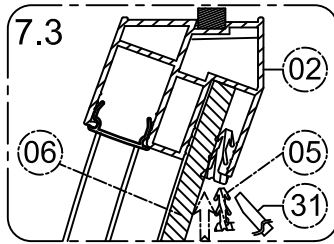
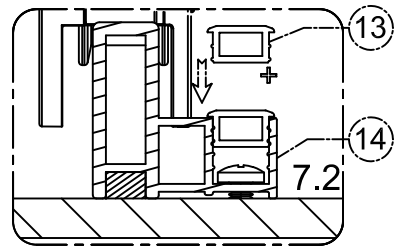
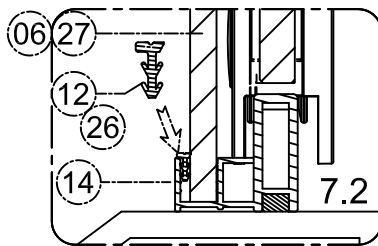
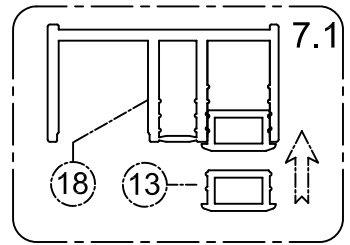
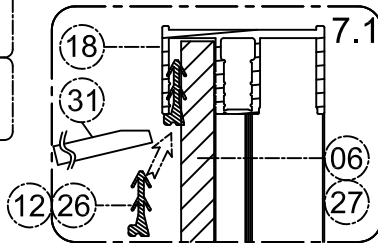
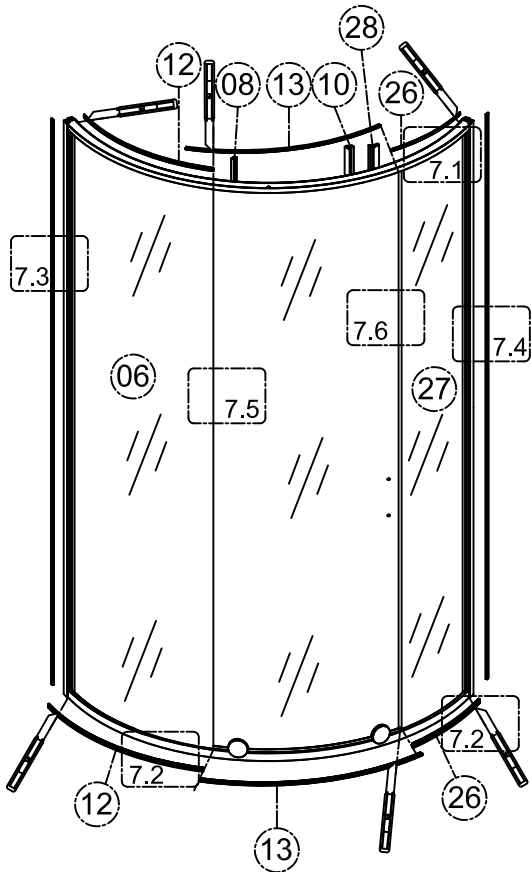
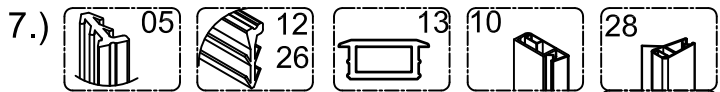

9.)

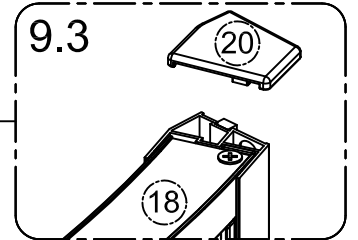
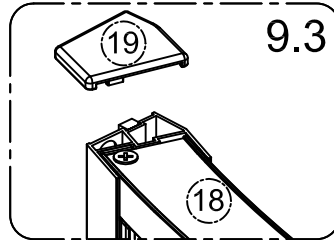
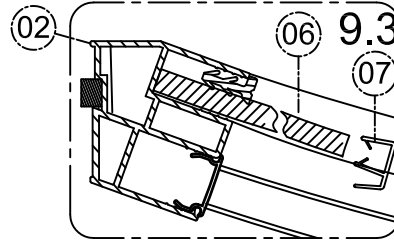
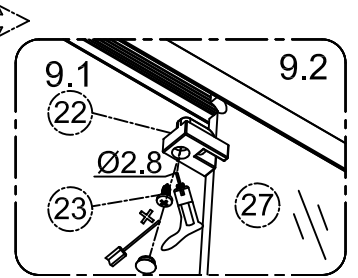
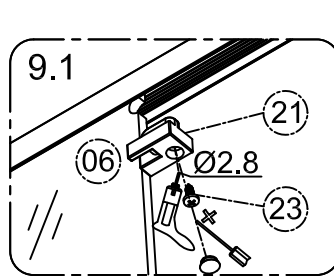
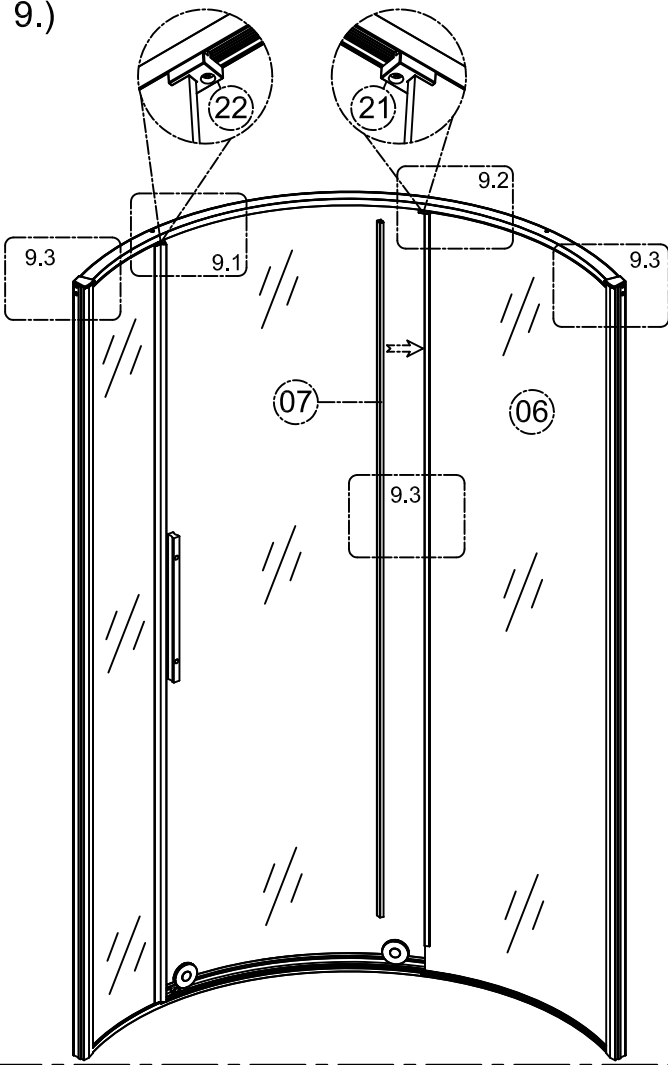

10.)

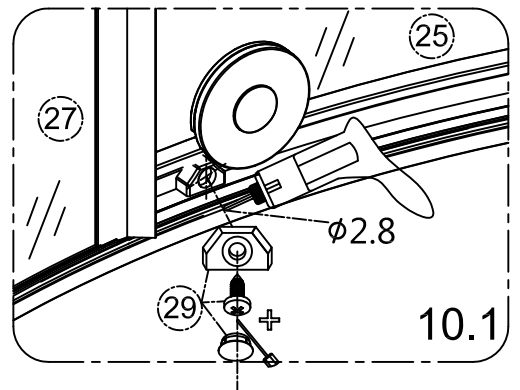
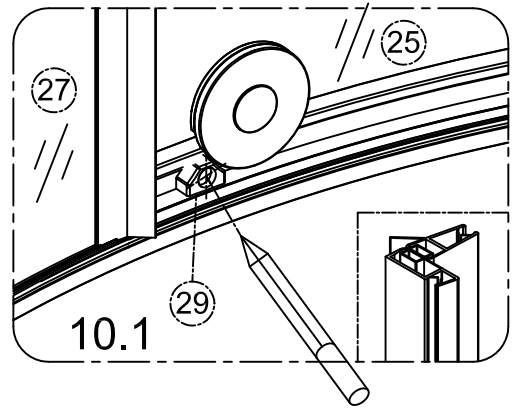
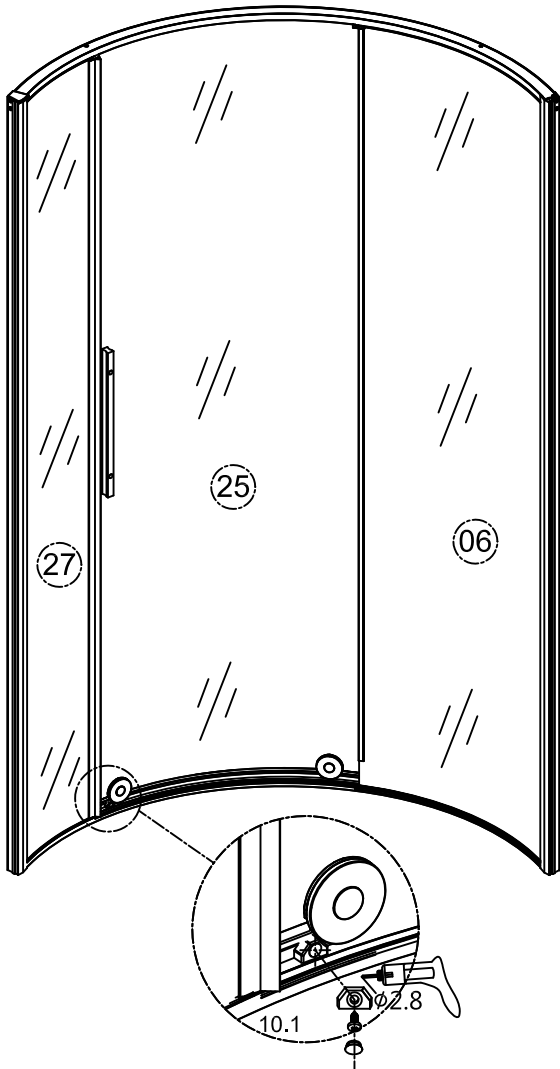



C/ COMERÇ 2 - P.I. COMTE DE SERT 08755
CASTELLBISBAL, BARCELONA, SPAIN